

PROJECT	
TYPE	
SPECIFIER	
QUANTITY	
DATE	

DAU SINGLE SURFACE

D93041-

base number Finish
Options

- To build a product code in our configurator select the specify button on the base model # product page
- To build a manual product code on this datasheet choose from the options listed below in blue font and add the suffix to the base model #

GENERAL

Series: Dau
 Subseries: Dau Single
 Brand: Milan
 Division: Design
 Mounting Type: Surface
 Mounting Location: Wall
 Subcategory: Up/Down Light

PHYSICAL

Length (mm): 80
 Length (in): 3 1/8
 Height (mm): 80
 Depth (mm): 101
 Height (in): 3 1/8
 Depth (in): 4
 Extension (mm): 101
 Extension (in): 4
 Light Distribution: Direct / Indirect
 Weight (kg): 0.82
 Weight (lbs): 1.81
 Fixture Finish: BAL / MWL / BSL
 Fixture Material: Extruded Aluminum

ELECTRICAL

Number of Lamps: 1
 Lamp Type: LED Retrofit
 Lamp Shape: T4
 Bulb Included: Bulb Not Included
 Max. Wattage Per Lamp (W): 3.5
 Lamp Base: G9
 Input Voltage (V): 120Vac Direct Line

LED

OPTICAL

RATINGS AND CERTIFICATIONS

Certified By: Certified for North American Standards
 IP rating: IP20

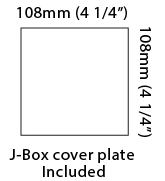

80mm 3 1/8"

101mm 4"

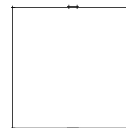

80mm 3 1/8"

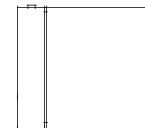

DAU SINGLE SURFACE

D93041-

PROJECT	_____
TYPE	_____
SPECIFIER	_____
QUANTITY	_____
DATE	_____



D

DAU SINGLE SURFACE

D93044-

base number Finish
Options

- To build a product code in our configurator select the specify button on the base model # product page
- To build a manual product code on this datasheet choose from the options listed below in blue font and add the suffix to the base model #

GENERAL

Series: Dau
Subseries: Dau Single
Brand: Milan
Division: Design
Mounting Type: Surface
Mounting Location: Wall
Subcategory: Up/Down Light

PHYSICAL

Shape: Rectangle
Length (mm): 80
Length (in): 3 1/8
Height (mm): 174
Depth (mm): 101
Height (in): 6 9/11
Depth (in): 4
Extension (mm): 101
Extension (in): 4
Light Distribution: Direct / Indirect
Weight (kg): 1.23
Weight (lbs): 2.71
[Fixture Finish: BAL / MWL / BSL](#)
Fixture Material: Extruded Aluminum

ELECTRICAL

Number of Lamps: 2
Lamp Type: LED Retrofit
Lamp Shape: MR16
Bulb Included: Bulb Not Included
Max. Wattage Per Lamp (W): 5
Lamp Base: GU10
Input Voltage (V): 120Vac Direct Line

LED

OPTICAL

RATINGS AND CERTIFICATIONS

Certified By: Certified for North American Standards
IP rating: IP20

PROJECT	_____
TYPE	_____
SPECIFIER	_____
QUANTITY	_____
DATE	_____

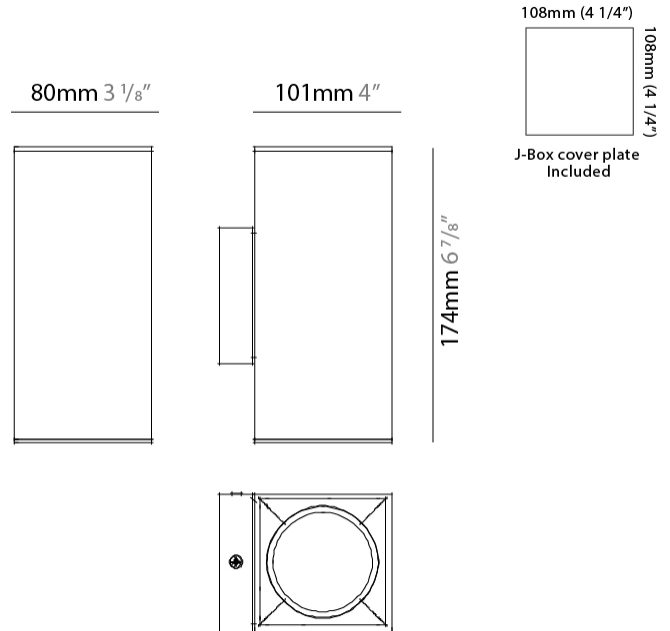

DAU SINGLE SURFACE

D93044-

PROJECT

TYPE

SPECIFIER

QUANTITY

DATE



DAU DOUBLE SURFACE

D93095-

base number Finish
 Options

- To build a product code in our configurator select the specify button on the base model # product page
- To build a manual product code on this datasheet choose from the options listed below in blue font and add the suffix to the base model #

GENERAL

Series: Dau _____
 Subseries: Dau Double _____
 Brand: Milan _____
 Division: Design _____
 Mounting Type: Surface _____
 Mounting Location: Wall _____
 Subcategory: Up/Down Light _____

PHYSICAL

Shape: Rectangle _____
 Length (mm): 180 _____
 Length (in): 7 1/16 _____
 Height (mm): 80 _____
 Depth (mm): 101 _____
 Height (in): 3 1/8 _____
 Depth (in): 4 _____
 Extension (mm): 101 _____
 Extension (in): 4 _____
 Light Distribution: Direct / Indirect _____
 Fixture Finish: BAL / MWL / BSL _____
 Fixture Material: Extruded Aluminum _____

ELECTRICAL

Number of Lamps: 2 _____
 Lamp Type: LED Retrofit _____
 Lamp Shape: T4 _____
 Bulb Included: Bulb Not Included _____
 Max. Wattage Per Lamp (W): 3.5 _____
 Lamp Base: G9 _____
 Input Voltage (V): 120Vac Direct Line _____

LED

OPTICAL

RATINGS AND CERTIFICATIONS

Certified By: Certified for North American Standards _____
 IP rating: IP20 _____

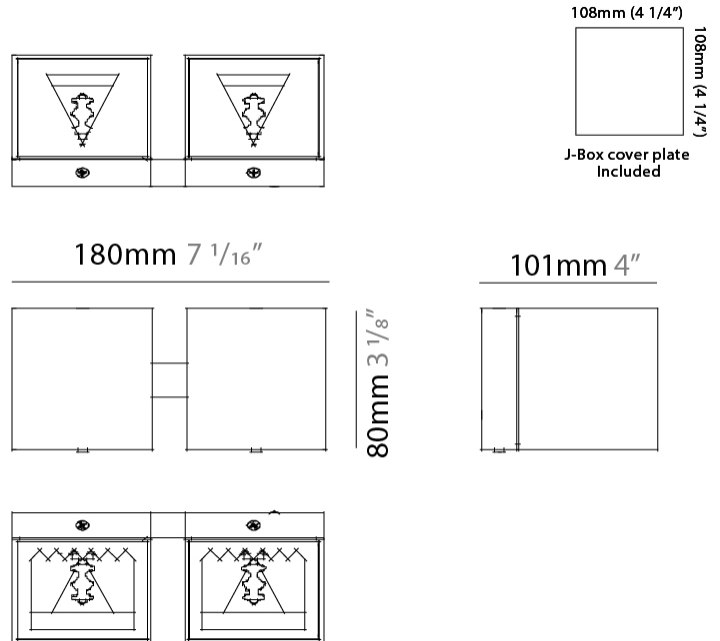

DAU DOUBLE SURFACE

D93095-

PROJECT

TYPE

SPECIFIER

QUANTITY

DATE

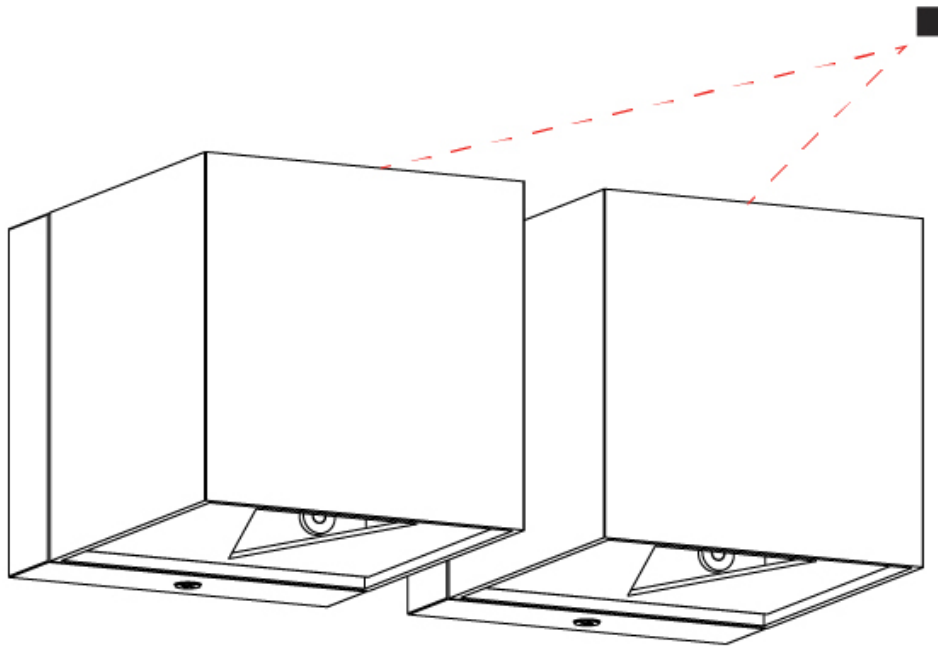

D

PROJECT	_____
TYPE	_____
SPECIFIER	_____
QUANTITY	_____
DATE	_____

DAU MINI SINGLE SURFACE

D93130R9-

base number _____
 Finish Options _____

- To build a product code in our configurator select the specify button on the base model # product page
- To build a manual product code on this datasheet choose from the options listed below in blue font and add the suffix to the base model #

GENERAL

Series: Dau _____
 Subseries: Dau Mini Single _____
 Brand: Milan _____
 Division: Design _____
 Mounting Type: Surface _____
 Mounting Location: Wall _____
 Subcategory: Up/Down Light _____

PHYSICAL

Shape: Cube _____
 Length (mm): 50 _____
 Length (in): 1 ¹⁵/₁₆ _____
 Height (mm): 50 _____
 Height (in): 1 ¹⁵/₁₆ _____
 Extension (mm): 60 _____
 Extension (in): 2 ³/₈ _____
 Light Distribution: Direct / Indirect _____
 Fixture Finish: CHR / MBL / MWL _____
 Fixture Material: Extruded Aluminum _____

ELECTRICAL

Lamp Type: LED _____
 Total Output Wattage (W): 10 _____
 Dimming: Electronic Low Voltage Dimming _____
 Input Voltage (V): 120Vac Direct Line _____

LED

Number of LEDs: 2 _____
 Color Temperature (°K): 3000 _____
 Max. Delivered Lumen (lm): 1000 _____
 CRI: >90 CRI _____

OPTICAL

RATINGS AND CERTIFICATIONS

Certified By: Certified for North American Standards _____
 IP rating: IP20 _____

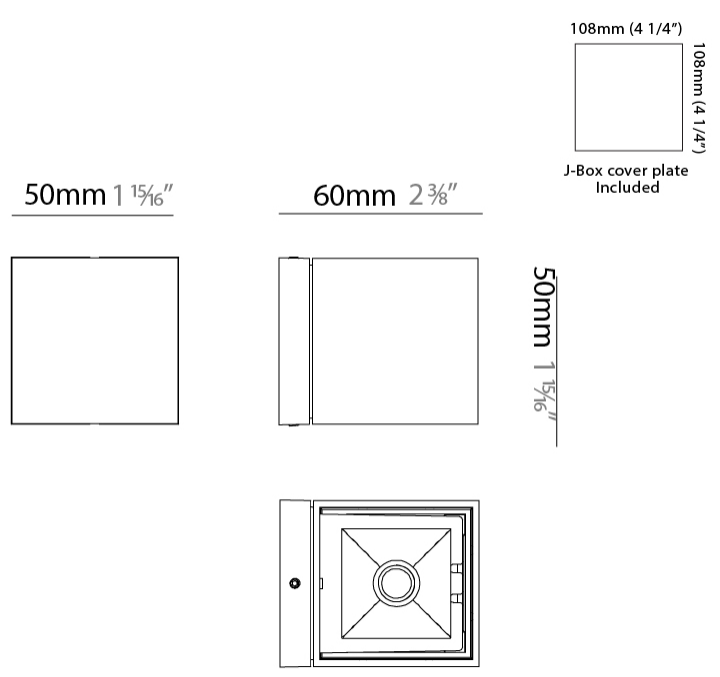

DAU MINI SINGLE SURFACE

D93130R9-

PROJECT	_____
TYPE	_____
SPECIFIER	_____
QUANTITY	_____
DATE	_____

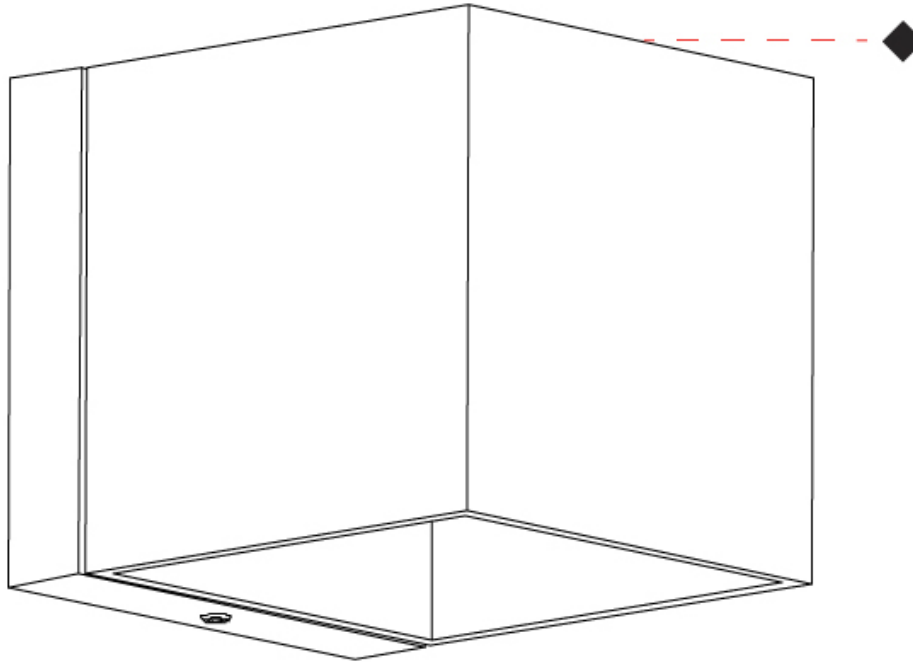

PROJECT _____
 TYPE _____
 SPECIFIER _____
 QUANTITY _____
 DATE _____

DAU 2 LIGHT LINEAR SURFACE

D93241-

base number _____
 Finish Options _____

- To build a product code in our configurator select the specify button on the base model # product page
- To build a manual product code on this datasheet choose from the options listed below in blue font and add the suffix to the base model #

GENERAL

Series: Dau _____
 Subseries: Dau 2 light Linear _____
 Brand: Milan _____
 Division: Design _____
 Mounting Type: Surface _____
 Mounting Location: Wall _____
 Subcategory: Up/Down Light _____

PHYSICAL

Shape: Rectangle _____
 Length (mm): 80 _____
 Length (in): 3 1/8 _____
 Height (mm): 80 _____
 Depth (mm): 101 _____
 Height (in): 3 1/8 _____
 Depth (in): 4 _____
 Light Distribution: Direct / Indirect _____
 Fixture Finish: BAL / MWL / BSL _____
 Fixture Material: Extruded Aluminum _____

ELECTRICAL

Lamp Type: LED _____
 Input Wattage (W): 28 _____
 Dimming: Electronic Low Voltage Dimming _____
 Input Voltage (V): 120Vac Direct Line _____

LED

Number of LEDs: 4 _____
 Color Temperature (°K): 3000 _____
 Max. Delivered Lumen (lm): 1330 _____
 CRI: >90 CRI _____
 Lamp Life (hrs): 50000 _____

OPTICAL

RATINGS AND CERTIFICATIONS

Certified By: Certified for North American Standards _____
 IP rating: IP20 _____

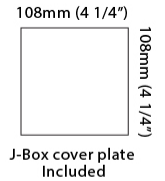
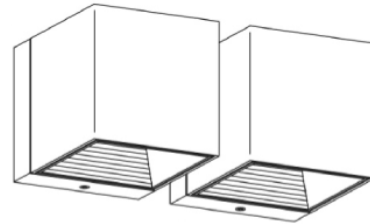

180mm 7 1/16"

101mm 4"

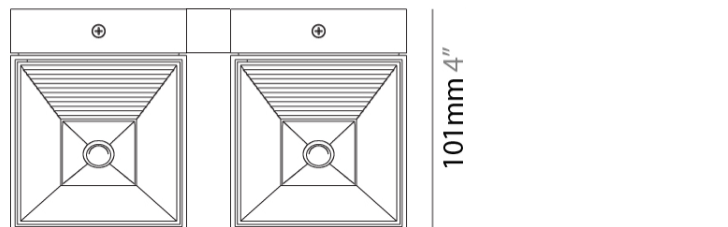

PROJECT

TYPE

SPECIFIER

QUANTITY

DATE

Fixture Finish

Brushed Aluminum - BAL



Matte White Lacquer - MWL



Black Satin Aluminum - BSL

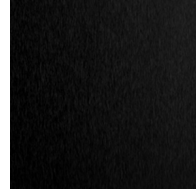

Chrome - CHR

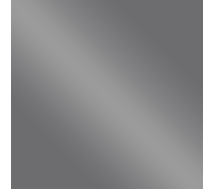





































































Digital: Not all screens are calibrated the same, and therefore, colors will appear differently between screens.

Physical: When texture is involved, there will be variations in color, character and tone within a product series and between product families.













PROJECT	
TYPE	
SPECIFIER	
QUANTITY	
DATE	











LEGEND

 floor-mounted	 pivotable	 special LED (upon request) RGB, RGBW, tunable, gold+, meat+, art+, fashion+
 wall and ceiling: recessed and surface mounted	 rotating	 warm dim / natural dimming LED
 ceiling-mounted and wall-mounted	 illuminate tilted	 rechargeable battery powered
 wall-mounted	 color of suspension cable	 fixture with natural vivid LED (upon request)
 omni-directional light distribution	 length of suspension cable	 color rendering index
 direct light distribution	 reflector degree selection	 color temperature
 direct/indirect light distribution	 super spot	 lumen (luminous flux)
 indirect light distribution	 lens	 efficacy (lumens per watt)
 asymmetric light distribution	 lens pack	 Unified Glare Rating (UGR) range from 5-40
 aura light distribution	 shine ring	 marine grade (AISI 316 stainless steel)
 round wall or ceiling cut-out	 integrated shine ring with diffuser	 walk on
 square wall or ceiling cut-out	 free individual colors 01-29	 drive on
 the supplied jig specifies the cutout dimensions	 individual colors: 00 (free of charge), 01-25 (extra charge)	 Dark Sky Compliance
 minimum distance (meters) lamp - object	 luminaire part to be colored (F1)	 Americans with Disabilities Act (less than 4" off the wall located between 27"-84" from floor)
 recessed depth	 luminaire part to be colored (F2)	 lamp protected against explosion
 ceiling thickness in mm	 luminaire part to be colored (F3)	 blown glass using traditional methods by master glass blower
 ceiling thickness selection	 luminaire part to be colored (F4)	 acoustic material
 dimmable DP (phase), DV (0-10V), DD (dali), DS (step-dim)	 luminaire part to be colored (F5)	 protection class I, protection insulation
 included or excluded LED driver/transformer/control gear	 color of 3-circuit adaptor	 protection class II, protection insulation
 separately switchable	 indirect diffuser	 ETL Certified to UL and CSA Standards
 sensor	 direct diffuser	 UL Certified to UL and CSA Standards
 remote control	 ball-proof (upon request)	 CSA Certified to UL and CSA Standards
 available upon request	 accessory	 Certified for North American Standards

IP RATING

 IP20	protected against ingress of solid bodies greater than 12.5mm (finger)
 IP33	protected against ingress of solid bodies greater than 2.5mm protected against sprays of water up to 60 degrees from the vertical (rain)
 IP40	protected against ingress of solid bodies greater than 1mm (wire) no protection against the ingress of moisture
 IP43	protected against ingress of solid bodies greater than 1mm (wire) protected against sprays of water up to 60 degrees from the vertical (rain)
 IP44	protected against ingress of solid bodies greater than 1mm (wire) protected against water splashed from all directions
 IP54	protected against limited ingress of dust (wet rooms/covered outdoor areas) protected against water splashed from all directions
 IP65	protected against ingress of dust protected against jets of water
 IP66	protected against ingress of dust protected against powerful jets of water or heavy seas
 IP67	protected against ingress of dust protected against immersion of water between 15cm - 1m for 30 minutes
 IP68	protected against ingress of dust protected against immersion of water under pressure for long periods

IK RATING

 IK01	protected against 0.14 joules impact (equivalent to 0.25kg mass dropped from 56mm above the surface)
 IK02	protected against 0.2 joules impact (equivalent to 0.25kg mass dropped from 80mm above the surface)
 IK03	protected against 0.35 joules impact (equivalent to 0.25kg mass dropped from 140mm above the surface)
 IK04	protected against 0.5 joules impact (equivalent to 0.25kg mass dropped from 200mm above the surface)
 IK05	protected against 0.7 joules impact (equivalent to 0.25kg mass dropped from 280mm above the surface)
 IK06	protected against 1 joules impact (equivalent to 0.25kg mass dropped from 400mm above the surface)
 IK07	protected against 2 joules impact (equivalent to 0.5kg mass dropped from 400mm above the surface)
 IK08	protected against 5 joules impact (equivalent to 1.7kg mass dropped from 300mm above the surface)
 IK09	protected against 10 joules impact (equivalent to 5.0kg mass dropped from 200mm above the surface)
 IK10	protected against 20 joules impact (equivalent to 5.0kg mass dropped from 400mm above the surface)